



TRACKED EXCAVATOR | JS130/145 LC/HD

Engine power: 81kW (109hp) | Bucket capacity: 0.35 - 0.89m³ | Operating weight: 13,911 - 16,627kg



STRENGTH INSIDE AND OUT.

BEFORE YOU BUY AN EXCAVATOR, YOU NEED TO KNOW IT'S GOING TO BE TOUGH ENOUGH TO PERFORM ANY JOB YOU ASK OF IT. FORTUNATELY, WITH A JCB JS130/I45, STRENGTH AND DURABILITY COME AS STANDARD.

We use Finite Element Analysis with extensive rig and endurance testing to make key components last longer.



Boom and dipper.

- 1 A JCB JS130/I45's reinforced boom and dipper is made of high tensile strength steel, with single piece wrapper plates and internal baffle plates for long life durability.
- 2 Our advanced manufacturing and assembly processes produce high precision and quality assembled components.

1

Componentry.

- 3 Our engine technology is tried and proven; we've built 200,000 DIESELMAX units since 2004. To ensure similar longevity, the JS130/I45's EcoMAX engines have been tested for 110,000 hours in 70 different machines across the toughest applications and environments.
- 4 JCB JS130/I45s boast the best components in the industry, including Berco running gear, Kawasaki pumps, Kayaba valve blocks and JCB EcoMAX engines.



2



3



4



Structural strength.

- 5 The high-strength undercarriage of a JCB JS130/145 uses a fully-welded X frame construction for long-term durability even in the most demanding applications.
- 6 A closed box section revolving frame increases strength and reduces stress. It's also highly resistant to impact damage.
- 7 The JS130/145 high-strength rigid upper frame provides maximum durability and support.
- 8 Our stiff, durable door design gives great strength and rigidity.

UNEARTHED: KEY FACT

The JCB JS130/145 turret is welded to both the upper and lower undercarriage frame.



5

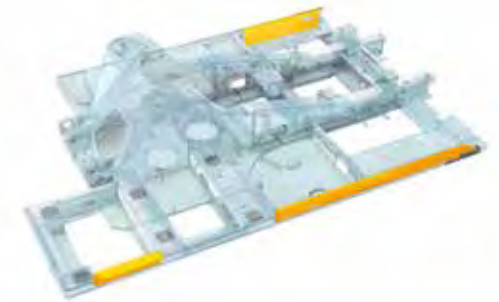

6



8



7

MAXIMUM PRODUCTIVITY, MINIMUM SPEND.

SAVING MONEY AND TIME IS MORE IMPORTANT THAN EVER, SO WE'VE MADE SURE THE NEW JCB JSI30/I45'S COMPONENTRY – INCLUDING THE ECOMAX T4F ENGINE – WORKS IN PERFECT HARMONY. IN TURN, YOU GET A MACHINE THAT'S AS EFFICIENT AND PRODUCTIVE AS POSSIBLE.

Versed in versatility.

1 JCB's quickhitch system makes attachment changing fast and easy, and is purpose-designed for the JS range.

JCB offers a full list of auxiliary pipework options including hammer, auxiliary, and low flow. For ultra versatility these auxiliary options are available with proportional controls.

2 An optional dozer blade increases versatility for grading. Choose the optional rubber street pads and you can use the JSI30/I45 on sensitive grounds like tarmac without causing damage.

3 A relatively low operating weight of 13.5T means the JSI30 can be towed on a 6-wheel lorry*, making it portable for plant hire and inner city/urban environments.

4 For waterway maintenance and deep extraction, or any application where reach is paramount, the JSI45 is available with a long reach boom and arm.

* Territory dependant



The JSI30/I45 are hugely versatile machines, made all the more so by a big range of attachments, enabling you to carry out a wide range of tasks.



Upping output.

6 Simultaneous tracking and excavating is smooth and fast with an intuitive multifunction operation.

6 A JCB JSI30/I45 has a solid, stable work platform for fast cycle times.

7 With a massive 92kNm bucket tearout and fast cycle times, the JSI30/I45 is extremely productive in all applications.

8 JCB's innovative hydraulic regeneration system means oil is recycled across the cylinders for faster cycle times and reduced fuel consumption.

The efficient excavator.

9 JCB's new EcoMAX T4 Final engine is more fuel efficient than our Tier 4i units, saving you money. This is partly due to the fact that EcoMAX produces high torque at just 1500 -1600 rpm, making for improved fuel-efficient matching of the hydraulics.

10 To reduce noise pollution from unnecessary air flow, the JSI30/I45's engine-driven cooling fan has a proportional control system, maintaining optimum fan speed.

11 Variable power bands allow you to tailor performance – and therefore economy – to specific tasks.



UNEARTHED: KEY FACT
A JCB JSI30/I45 has cushioned boom and dipper ends to prevent shock loadings, protect your machine and increase operator comfort.

To save fuel, JCB Auto-Idle technology automatically reduces engine speed when hydraulics aren't in use. To optimise fuel efficiency still further, the JSI30/I45 benefits from advanced hydraulic technology, including optimised hydraulic pump settings, advanced spool design, and cutting edge electronic management software.



A COMFORTABLE FAVOURITE.

JCB EXCAVATORS ARE DESIGNED AROUND THE OPERATOR. THAT'S GOOD FOR THEM BUT EVEN BETTER FOR YOU; AFTER ALL, GREAT COMFORT AND EASE OF USE EQUALS GREAT PRODUCTIVITY.

Visibly better.

1 A 70/30 front screen split gives JCB JS130/145s excellent front visibility. A clear view of the front right track provides easy, safe trench digging and manoeuvring.

2 An innovative low-level bonnet provides excellent rearward visibility.

Comfortably in control.

3 The 3.5" colour multi-function display is easy to read in all light conditions, provides instant operational information, and has a customisable home screen.

A 7" full colour display is available as an option when a rear camera or advanced tool select is ordered.



A large laminated glass roof window gives the JS130/145 optimum visibility for working at height.

Light, intuitive and smooth controls improve comfort and productivity. The JS130/145's joystick-mounted power boost button gives extra hydraulic power fast.

A balanced slew and electronic/hydraulic controlled slew braking give speed and precision.



The JS130/145's cab and controls are independently adjustable so that it's easy to find the perfect operating position.

The working environment.

4 The JS130/145 creates a quieter working environment inside and out. Because we've reduced noise levels to 72dB(A) inside and 99dB(A) outside, you can use the machine at any location, any time.

JCB cabs use 6 viscous rubber mounts to minimise noise and vibration.

The positive pressure cab keeps out dirt and dust.

5 JCB's climate control option offers a precisely controlled cab temperature with fresh or recirculated air. Demisting/defrosting functions keep a JS130/145's front window clear.

6 There's a spacious luggage tray behind the operator's seat.

7 A large floor area with large high grip pedals gives easy and precise tracking.



5



6



7



4

We offer air suspension, heated and ventilated seating options to suit many different applications.

LESS SERVICING, MORE SERVICE.

WE'VE DESIGNED THE JCB JS130/I45 TO BE LOW MAINTENANCE AND EASILY SERVICEABLE. THIS MAKES IT AFFORDABLE, EFFICIENT AND HIGHLY PRODUCTIVE, HELPING YOU GET THE BEST SERVICE FROM YOUR MACHINE.

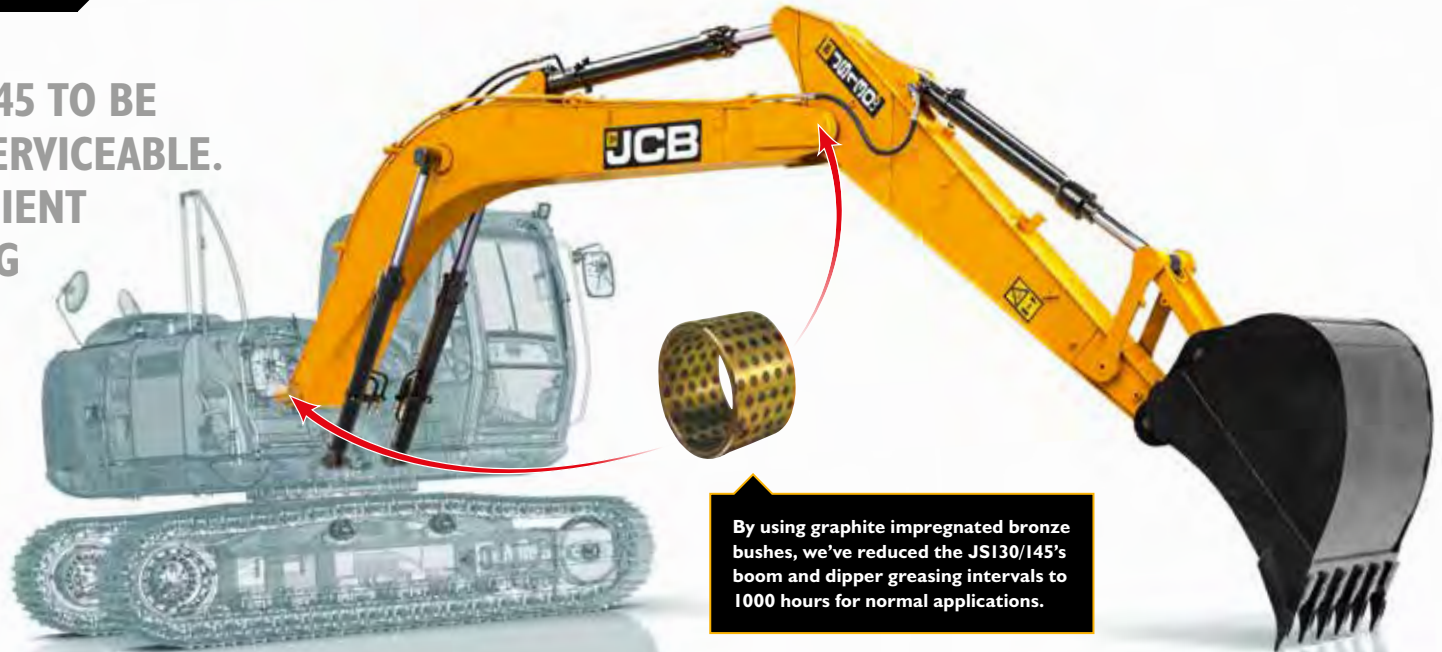

By using graphite impregnated bronze bushes, we've reduced the JS130/I45's boom and dipper greasing intervals to 1000 hours for normal applications.



Easy does it.

- 1 The air filter on a JS130/I45 is easily accessible, and a double-element construction simplifies cleaning.
- 2 The filters on a JS130/I45 (engine oil, hydraulic oil and fuel) are centrally located for fast, easy servicing.
- 3 Because they're mounted side by side on a JCB JS130/I45, the engine radiator, hydraulic cooler and intercooler can be serviced individually yet cleaned easily.

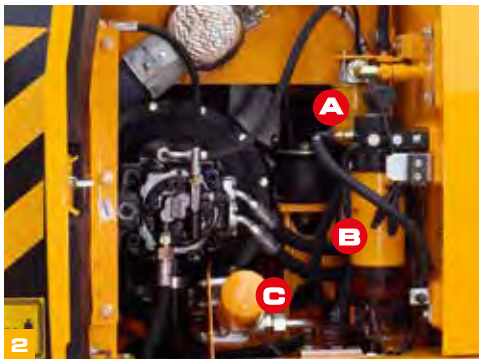

(A) Hydraulics oil filters (B) Fuel filters (C) Engine oil filter

SERVICE INTERVALS	
Engine oil and oil filter	Every 500 hours
Hydraulic oil	Every 5000 hours
Hydraulic oil filter	Every 1000 hours





4

Here to help.

4 The JCB EcoMax T4F engine does not require the use of a DPF and so removes the cost of any expensive servicing or repairs to the units.

5 We've eliminated the need for a visibowl style pre-cleaner on the JS130/145 with our new optional scavenger filtration system. This uses suction from the cooling fan to remove heavier particles from the induction system.

6 Our innovative recalibration option allows EcoMAX to run on lower grade fuels. This means the JS130/145 can be resold across different territories, which improves residuals.

7 JCB's In-Cab Monitor (7" option shown) checks engine oil levels, coolant, and system errors on start-up.

8 JCB meets the latest Tier 4 Final/ Stage IV emissions legislation without the use of a DPF (Diesel Particulate Filter). The Diesel exhaust fluid (DEF) tank can be easily accessed via the new revised step layout on the upper structure.



5



6



JCB JS130/145 bonnets open and close easily with gas-assisted cylinders, and the service bays are large and wide for good access.

UNEARTHED: KEY FACT
JCB JS130/145 grease points are centralised for safe and easy access to high level pivots.



7



8

THE SAFE CHOICE.

ON-SITE SAFETY IS CRUCIAL, SO WE'VE DESIGNED THE JCB JSI30/I45 TO INCORPORATE AS MANY CUTTING EDGE SAFEGUARDS AS POSSIBLE. IN SHORT, YOUR OPERATORS ARE IN SAFE HANDS.



1 The JSI30/I45 bonnet opens front-to-rear for easy and safe engine service access.



2 For extra peace of mind, JCB cabs are available with an integral Rollover Protection Structure (ROPS). It's also easy to fit JCB's Falling Objects Protection Structure (FOPS), thanks to standard fitment mounting brackets.

3 JCB JSI30/I45s have a large glass area and low bonnet line for superb visibility.

4 A JCB JSI30/I45's steps and platforms have anti-slip punched steel plates for optimum grip, even in wet or icy conditions. Bolt-on plates have recessed bolts to reduce trip hazards.

5 Our optional rear and side view cameras display uninterrupted rearwards and sideways views on the smart controller display.



We've fitted as standard a bulk head heat shield between the pumps and the engine to guard against heat and noise.



6 Your JS130/145 is equipped with a full set of side and rear view mirrors for all round visibility and safety compliance.

7 JCB's Safety Level Lock fully isolates hydraulic functions to avoid unintended movements. Our 2GO system means a JCB JS130/145 can only be started in a safe locked position via two separate inputs.

8 There's no need to climb onto the JS130/145 to check oil levels; all routine servicing can be done from ground level.

9 Optional safety rails protect operators from falls when they're on the upper structure of the JS130/145.

10 The JS130/145's optional beacons can improve on-site safety still further.

11 Choose LED work lights for an even better field of vision on the JS130/145.



7



8



9



11

LIVELINK, WORK SMARTER.

LIVELINK IS AN INNOVATIVE SOFTWARE SYSTEM THAT LETS YOU MANAGE JCB MACHINES REMOTELY – ONLINE, BY EMAIL OR BY MOBILE PHONE. ACCESS EVERYTHING FROM MACHINE ALERTS TO FUEL REPORTS AND HISTORY INFORMATION, WITH ALL DATA STORED AT A SECURE CENTRE.

Productivity and cost benefits.

By providing information like idle time monitoring and machine fuel consumption, JCB Livelink helps reduce your fuel usage, saving money and improving productivity. Machine location information can help improve efficiency and perhaps even reduce insurance costs.

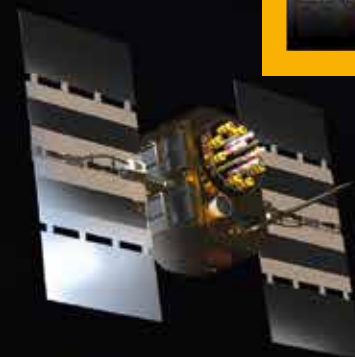

Maintenance benefits.

Manage machine maintenance easily – accurate hours monitoring and service alerts improve maintenance planning, while real-time location data helps you manage your fleet. Critical machine alerts and maintenance history records are also available.



Security benefits.

Livelink's real-time geofencing alerts tell you when machines move out of predetermined zones, and real-time curfew alerts inform you of unauthorised usage. Further benefits include real-time location information, advanced ECU matching (pairs Livelink with the immobiliser or ECU).



VALUE ADDED.

JCB'S WORLDWIDE CUSTOMER SUPPORT IS FIRST CLASS. WHATEVER YOU NEED AND WHEREVER YOU ARE, WE'LL BE AVAILABLE QUICKLY AND EFFICIENTLY TO HELP MAKE SURE YOUR MACHINERY IS PERFORMING TO ITS FULL POTENTIAL.



1

1 Our Technical Support Service provides instant access to factory expertise, day or night, while our Finance and Insurance teams are always on hand to provide fast, flexible, competitive quotes.

2 The global network of JCB Parts Centres is another model of efficiency; with 16 regional bases, we can deliver around 95% of all parts anywhere in the world within 24 hours. Our genuine JCB parts are designed to work in perfect harmony with your machine for optimum performance and productivity.

Note: JCB LIVELINK and JCB ASSETCARE may not be available in your region, so please check with your local dealer.



2

3 JCB Assetcare offers comprehensive extended warranties and service agreements, as well as service-only or repair and maintenance contracts. Irrespective of what you opt for, our maintenance teams around the world charge competitive labour rates, and offer non-obligation quotations as well as fast, efficient insurance repair work.



3

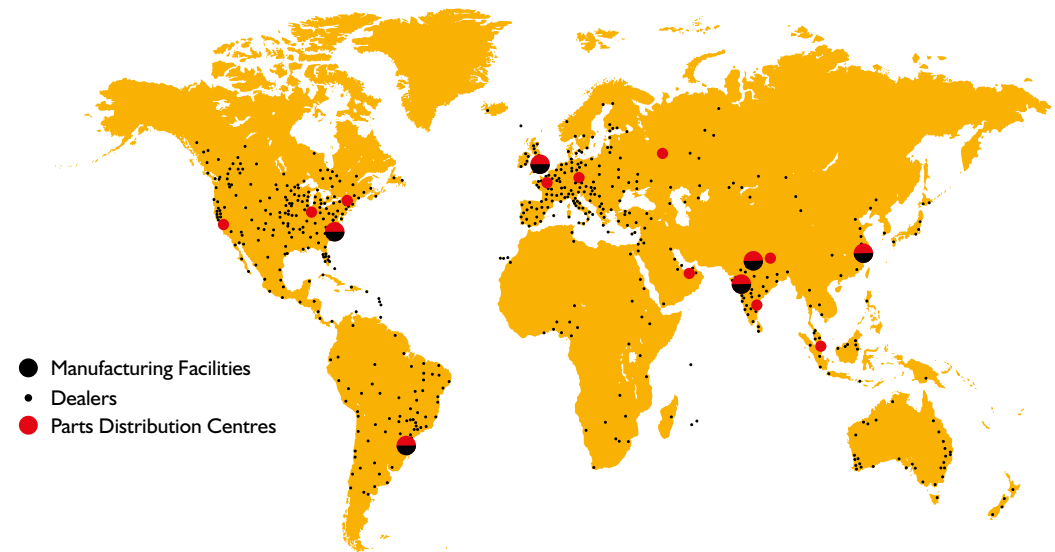

STATIC DIMENSIONS

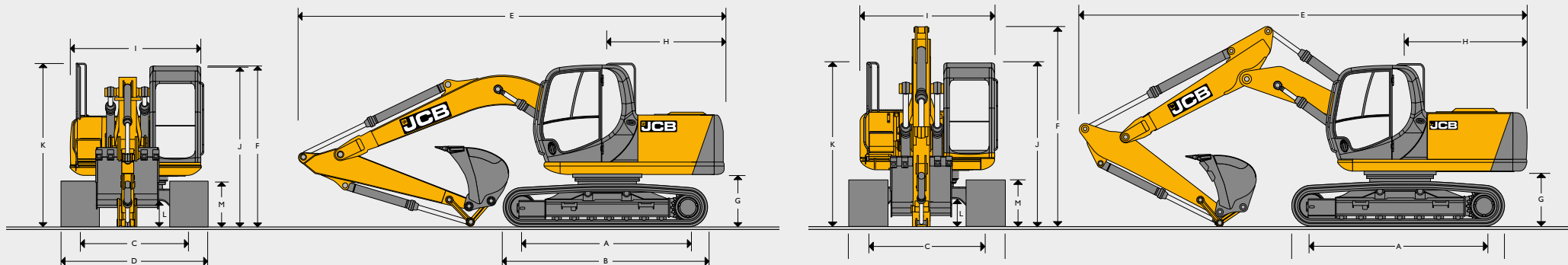

STATIC DIMENSIONS

Dimensions in mm	JSI30 LC				JSI145 LC				JSI145 HD											
A Track length on ground	2865				2865				3090											
B Undercarriage overall length	3590				3590				3940											
C Track Gauge	1990				1990				2200											
D Width over tracks (500mm trackshoes)	2490				2490				-											
D Width over tracks (600mm trackshoes)	2590				2590				2800											
D Width over tracks (700mm trackshoes)	2690				2690				2900											
D Width over tracks (800mm trackshoes)	-				-				3000											
D Width over tracks (850mm trackshoes)	2840				2840				-											
D Width over tracks (900mm trackshoes)	-				-				3100											
Boom options	Monoboomb 4.7m				Monoboomb 4.7m				T.A.B. 5.0m				Monoboomb 4.7m				T.A.B. 5.0m			
Arm lengths	2.1m	2.5m	2.7m	3.0m	2.1m	2.5m	2.7m	3.0m	2.1m	2.5m	2.7m	3.0m	2.1m	2.5m	2.7m	3.0m	2.1m	2.5m	2.7m	3.0m
E Transport length	7515	7478	7420	7300	7515	7478	7420	7300	8120	8086	8032	7933	7515	7478	7420	7300	8120	8086	8032	7933
F Transport height	3002	3002	3209	3289	3002	3002	3209	3396	3002	3002	2908	3236	3149	3149	3356	3543	3149	3149	2908	3236
G Counterweight clearance*	905				905				1050											
H Tail swing radius	2135				2135				2135											
I Width of superstructure	2410				2410				2410											
J Height over cab*	2845				2845				2895											
K Height over grab rail*	3002				3002				3149											
L Ground clearance*	425				425				470											
M Track height	811				811				880											

ENGINE

Model	JCB EcoMAX 444 TCA EU Stage IV EPA Tier 4 Final compliant
Type	4-stroke, 4-cylinder in-line, common rail, direct injection, turbocharged and intercooled diesel
Rated power (net)	81 kW (109 hp) at 2200rpm (ISO 14396)
Piston Displacement	4.4 litres
Air Filtration	Dry element with secondary safety element and in cab warning indicator
Starting system	24 volt
Batteries	2 x 12 volt
Alternator	24 volt 55 ampere

SLEW SYSTEM

Slew motor	Axial piston type
Slew brake	Hydraulic braking plus automatic spring applied disc type parking brake.
Slew torque	36.0 kNm
Slew speed	13.1 rpm.
Slew gear	Large diameter, internally toothed fully sealed grease bath lubricated.

UNDERCARRIAGE						
Carriage options	LC - Long Carriage, HD - Heavy Duty Carriage.					
Construction	Fully welded, 'X' frame type with central bellyguarding and sloping sidemembers with dirt relief holes under top rollers.					
Recovery point	Front and rear.					
Track shoes	500mm	600mm	700mm	800mm	850mm	900mm
JSI 30 LC	● X □	● □	●		●	
JSI 45 LC	● X □	□	●		●	
JSI 45 HD		●	●	●		●
Upper & lower rollers	Heat treated, sealed and lubricated.					
Track adjustment	Grease cylinder type.					
Track idler	Sealed and lubricated, with spring cushioned recoil.					
Track type	Sealed and lubricated.					
Rollers and shoes (each side)	JSI 30/145 LC			JSI 45 HD		
No. of track guides (optional)	1 (2)			1 (2)		
No. of lower rollers	7			7		
No. of upper rollers	2			2		
No. of track shoes	44			43		

● = Triple grouser, X = Geogrip, □ = Rubber shoes.

TRACK DRIVE		
Type	Fully hydrostatic, two speed with autoshift.	
Travel motors	Variable swash axial piston type, fully guarded within undercarriage frame.	
Final drive	Planetary reduction, bolt-on sprockets.	
Service brake	Hydraulic counter balance valve.	
Park brake	Disc type, spring applied, automatic hydraulic release.	
Gradeability	70% (35 deg) continuous.	
Travel speed	LC	HD
	High - 5.6 km/h Low - 3.3 km/h	High - 4.3 km/h Low - 2.5 km/h
Tractive effort	101.9 kNm	170.7 kNm

SERVICE CAPACITIES		Litres
Fuel tank		220
Engine coolant		19.7
Engine oil		14
Swing reduction gear		2.2
Track reduction gear (each side)		3.5
Hydraulic system		126
Hydraulic tank		73
DEF fluid capacity		54

HYDRAULIC SYSTEM	
Pumps	
Main pumps	2 variable displacement axial piston type.
Maximum flow	2 x 124 L/min.
Servo pump	Gear type.
Maximum flow	20 L/min.
Control valve	
A combined four and five spool control valve with auxiliary service spool as standard	
Relief valve settings	
Boom/Arm/Bucket	314 bar.
With power boost	343 bar.
Swing circuit	279 bar.
Travel circuit	343 bar.
Pilot control	40 bar.
Filtration	
In tank	150 micron, suction strainer.
Main return line	10 micron, glass fibre element.
Pilot line	10 micron, paper element.
Hydraulic hammer return	10 micron, reinforced microform element.

WEIGHTS AND GROUND BEARING PRESSURES						
	500mm shoes	600mm shoes	700mm shoes	800mm shoes	850mm shoes	900mm shoes
JSI 30 LC Monoboom - Machine equipped with 4.7m Monoboom, 2.5m Dipper, 417kg Excavating Bucket, operator and full fuel tank.						
Machine weight	kg	13991	14018	14126	-	14288
Ground bearing pressure	kg/cm ²	0.44	0.37	0.32	-	0.27
JSI 45 LC Monoboom - Machine equipped with 4.7m Monoboom, 2.5m Dipper, 417kg Excavating Bucket, operator and full fuel tank.						
Machine weight	kg	14511	14618	14726	-	14888
Ground bearing pressure	kg/cm ²	0.47	0.39	0.34	-	0.28
JSI 45 LC T.A.B. - Machine equipped with 5.0m T.A.B., 2.5m Dipper, 417kg Excavating Bucket, operator and full fuel tank.						
Machine weight	kg	14995	15102	15210	-	15372
Ground bearing pressure	kg/cm ²	0.48	0.40	0.35	-	0.29
JSI 45 HD Monoboom - Machine equipped with 4.7m Monoboom, 2.5m Dipper, 417kg Excavating Bucket, operator and full fuel tank.						
Machine weight	kg	-	15276	15384	15492	-
Ground bearing pressure	kg/cm ²	-	0.41	0.35	0.31	-
JSI 45 HD T.A.B. - Machine equipped with 5.0m T.A.B., 2.5m Dipper, 417kg Excavating Bucket, operator and full fuel tank.						
Machine weight	kg	-	15276	15868	15976	-
Ground bearing pressure	kg/cm ²	-	0.42	0.36	0.32	-

BUCKET AND ARM COMBINATION - MONOBOOM

Bucket options	GP Bucket							Grade Bucket		
	mm	600	700	800	1000	1200	1300	1524	1836	1836
Bucket width	mm	600	700	800	1000	1200	1300	1524	1836	1836
Bucket capacity	m ³	0.35	0.42	0.50	0.66	0.81	0.89	0.65	0.79	0.79
Bucket weight	kg	286	312	335	383	428	454	452	512	581

JSI30 LC Monoboom

2.10m Quickhitch (No Quickhitch)	□ (□)	□ (□)	□ (□)	■ (□)	● (■)	● (■)	■ (□)	● (■)	● (■)
2.50m Quickhitch (No Quickhitch)	□ (□)	□ (□)	□ (□)	■ (□)	● (■)	● (●)	■ (■)	● (●)	● (●)
2.70m Quickhitch (No Quickhitch)	□ (□)	□ (□)	□ (□)	■ (■)	● (●)	X (●)	● (■)	● (●)	X (●)
3.00m Quickhitch (No Quickhitch)	□ (□)	□ (□)	□ (□)	● (■)	X (●)	X (●)	● (■)	X (●)	X (●)

JSI45 LC Monoboom

2.10m Quickhitch (No Quickhitch)	□ (□)	□ (□)	□ (□)	□ (□)	■ (□)	■ (■)	□ (□)	■ (□)	■ (□)
2.50m Quickhitch (No Quickhitch)	□ (□)	□ (□)	□ (□)	□ (□)	■ (■)	● (■)	□ (□)	■ (■)	● (■)
2.70m Quickhitch (No Quickhitch)	□ (□)	□ (□)	□ (□)	□ (□)	■ (■)	● (■)	■ (□)	● (■)	● (■)
3.00m Quickhitch (No Quickhitch)	□ (□)	□ (□)	□ (□)	□ (■)	● (■)	● (●)	■ (□)	● (●)	● (●)

JSI45 HD Monoboom

2.10m Quickhitch (No Quickhitch)	□ (□)	□ (□)	□ (□)	□ (□)	□ (□)	□ (□)	□ (□)	□ (□)	□ (□)
2.50m Quickhitch (No Quickhitch)	□ (□)	□ (□)	□ (□)	□ (□)	■ (□)	■ (■)	□ (□)	■ (□)	■ (□)
2.70m Quickhitch (No Quickhitch)	□ (□)	□ (□)	□ (□)	□ (□)	□ (□)	■ (□)	□ (□)	■ (□)	■ (□)
3.00m Quickhitch (No Quickhitch)	□ (□)	□ (□)	□ (□)	□ (□)	■ (■)	● (■)	□ (□)	■ (■)	● (■)

- = Material weight up to 1800kg/m³.
- = Material weight up to 1500kg/m³.
- = Material weight up to 1200kg/m³.

These recommendations are given as a guide based on typical operating conditions. Please contact your distributor for the correct selection of buckets and attachments to suit the application.

BUCKET AND ARM COMBINATION - T.A.B.

Bucket options	GP Bucket							Grade Bucket		
	mm	600	700	800	1000	1200	1300	1524	1836	1836
Bucket width	mm	600	700	800	1000	1200	1300	1524	1836	1836
Bucket capacity	m ³	0.35	0.42	0.50	0.66	0.81	0.89	0.65	0.79	0.79
Bucket weight	kg	286	312	335	383	428	454	452	512	581

JSI45 LC T.A.B.

2.10m Quickhitch (No Quickhitch)	□ (□)	□ (□)	□ (□)	□ (□)	■ (■)	● (■)	■ (□)	● (■)	● (■)
2.50m Quickhitch (No Quickhitch)	□ (□)	□ (□)	□ (□)	■ (□)	● (■)	● (●)	■ (□)	● (■)	● (●)
2.70m Quickhitch (No Quickhitch)	□ (□)	□ (□)	□ (□)	■ (□)	● (■)	X (●)	■ (■)	● (●)	X (●)
3.00m Quickhitch (No Quickhitch)	□ (□)	□ (□)	□ (□)	● (■)	● (●)	X (●)	● (■)	X (●)	X (●)

JSI45 HD T.A.B.

2.10m Quickhitch (No Quickhitch)	□ (□)	□ (□)	□ (□)	□ (□)	□ (□)	■ (□)	□ (□)	□ (□)	■ (□)
2.50m Quickhitch (No Quickhitch)	□ (□)	□ (□)	□ (□)	□ (□)	■ (□)	■ (■)	□ (□)	■ (□)	■ (■)
2.70m Quickhitch (No Quickhitch)	□ (□)	□ (□)	□ (□)	□ (□)	■ (■)	● (■)	□ (□)	■ (■)	● (■)
3.00m Quickhitch (No Quickhitch)	□ (□)	□ (□)	□ (□)	□ (□)	● (■)	● (●)	■ (□)	● (■)	● (■)

- = Material weight up to 1800kg/m³.
- = Material weight up to 1500kg/m³.
- = Material weight up to 1200kg/m³.

These recommendations are given as a guide based on typical operating conditions. Please contact your distributor for the correct selection of buckets and attachments to suit the application.

OPTIONAL BLADE

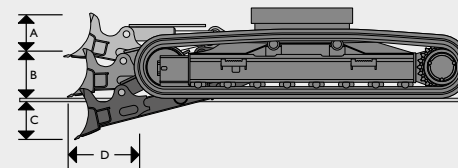

A	Blade height	mm	490
B	Blade lift above ground	mm	440
C	Blade cut below ground	mm	510
D	Blade forward of track	mm	440
	Dozer width – 500mm tracks	mm	2510
	Dozer width – 600mm tracks	mm	2610
	Dozer width – 700mm tracks	mm	2710

Additional machine weight with blade		
500mm tracks	kg	747
600mm tracks	kg	753
700mm tracks	kg	759

Dozer not available with 800, 850 and 900mm track plates.

WORKING RANGE - JSI30 LC MONOBOOM 4.7M						
Dipper length:		2.1m	2.5m	2.7m	3.0m	
A	Maximum digging reach	mm	7517	8340	8522	8796
B	Maximum digging reach (on ground)	mm	7356	8197	8380	8660
C	Maximum digging depth	mm	4809	5530	5425	6028
D	Maximum digging height	mm	8375	9118	9242	9440
E	Maximum dumping height	mm	6115	6729	6855	7041
F	Maximum vertical wall cut depth	mm	3219	3625	4444	4050
G	Minimum swing radius	mm	2337	2231	2505	2591
	Bucket rotation	deg	182°	182°	182°	182°
	Maximum dipper tearout	kNm	72.5	64.6	63.2	58.7
	Maximum bucket tearout	kNm	91.9	91.9	91.9	91.9

WORKING RANGE - JSI45 LC MONOBOOM 4.7M						
Dipper length:		2.1m	2.5m	2.7m	3.0m	
A	Maximum digging reach	mm	7517	8340	8522	8796
B	Maximum digging reach (on ground)	mm	7356	8197	8380	8660
C	Maximum digging depth	mm	4809	5530	5425	6028
D	Maximum digging height	mm	8375	9118	9242	9440
E	Maximum dumping height	mm	6115	6729	6855	7041
F	Maximum vertical wall cut depth	mm	3219	3625	4444	4050
G	Minimum swing radius	mm	2337	2231	2505	2591
	Bucket rotation	deg	182°	182°	182°	182°
	Maximum dipper tearout	kNm	72.5	64.6	63.2	58.7
	Maximum bucket tearout	kNm	91.9	91.9	91.9	91.9

WORKING RANGE - JSI45 HD MONOBOOM 4.7M						
Dipper length:		2.1m	2.5m	2.7m	3.0m	
A	Maximum digging reach	mm	7517	8340	8522	8796
B	Maximum digging reach (on ground)	mm	7356	8197	8380	8660
C	Maximum digging depth	mm	4662	5383	5278	5881
D	Maximum digging height	mm	8522	9265	9389	9587
E	Maximum dumping height	mm	6262	6876	7002	7188
F	Maximum vertical wall cut depth	mm	3072	3478	4297	3903
G	Minimum swing radius	mm	2337	2231	2505	2591
	Bucket rotation	deg	182°	182°	182°	182°
	Maximum dipper tearout	kNm	72.5	64.6	63.2	58.7
	Maximum bucket tearout	kNm	91.9	91.9	91.9	91.9

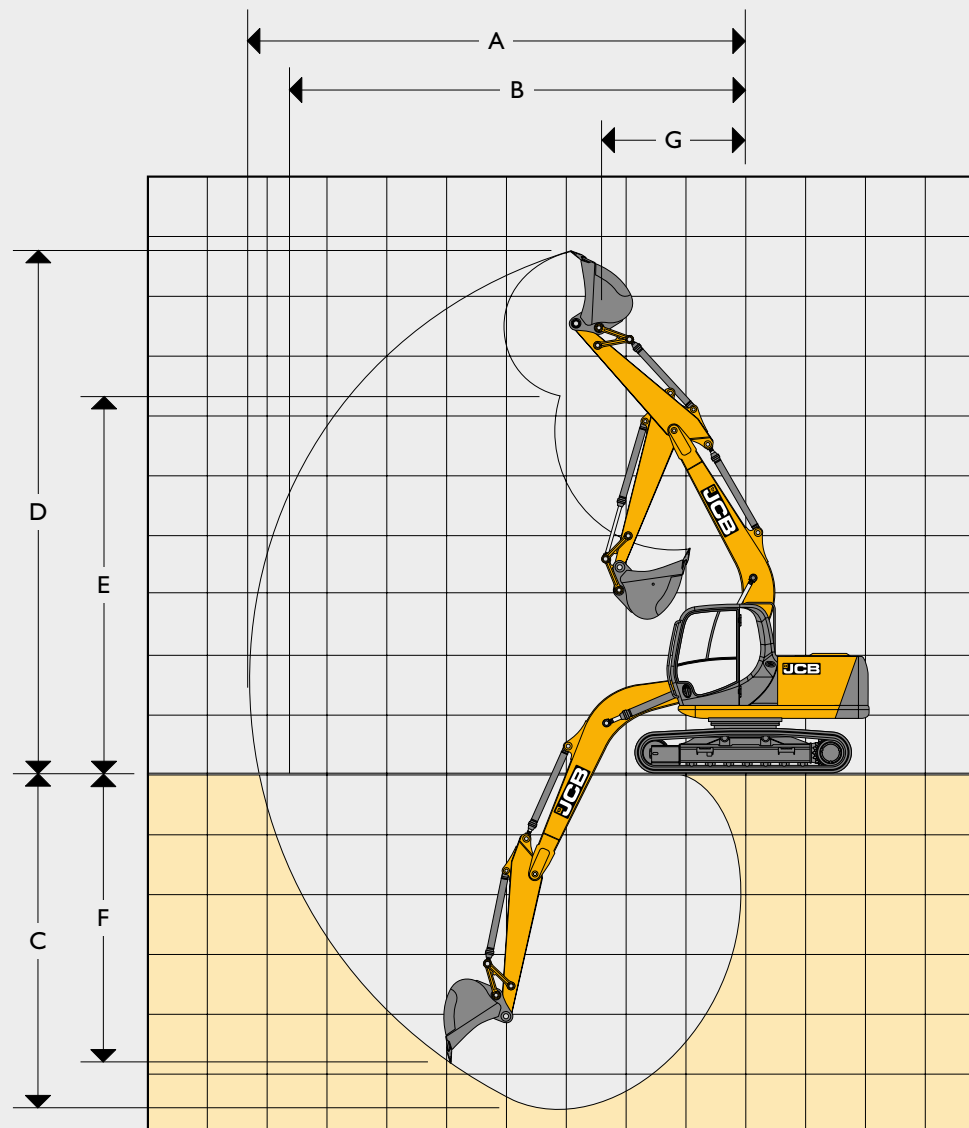

WORKING RANGE - JS145 LC T.A.B. 5.0M

Dipper length:		2.1m	2.5m	2.7m	3.0m
A	Maximum digging reach	mm	8266	8751	8840
B	Maximum digging reach (on ground)	mm	8199	8614	8700
C	Maximum digging depth	mm	5283	5786	5901
D	Maximum digging height	mm	9228	9653	9690
E	Maximum dumping height	mm	7005	7229	7468
F	Maximum vertical wall cut depth	mm	3933	4140	4518
G	Minimum swing radius	mm	2616	2746	3031
	Bucket rotation	deg	182°	182°	182°
	Maximum dipper tearout	kNm	72.5	64.6	63.2
	Maximum bucket tearout	kNm	91.9	91.9	91.9

WORKING RANGE - JS145 HD T.A.B. 5.0M



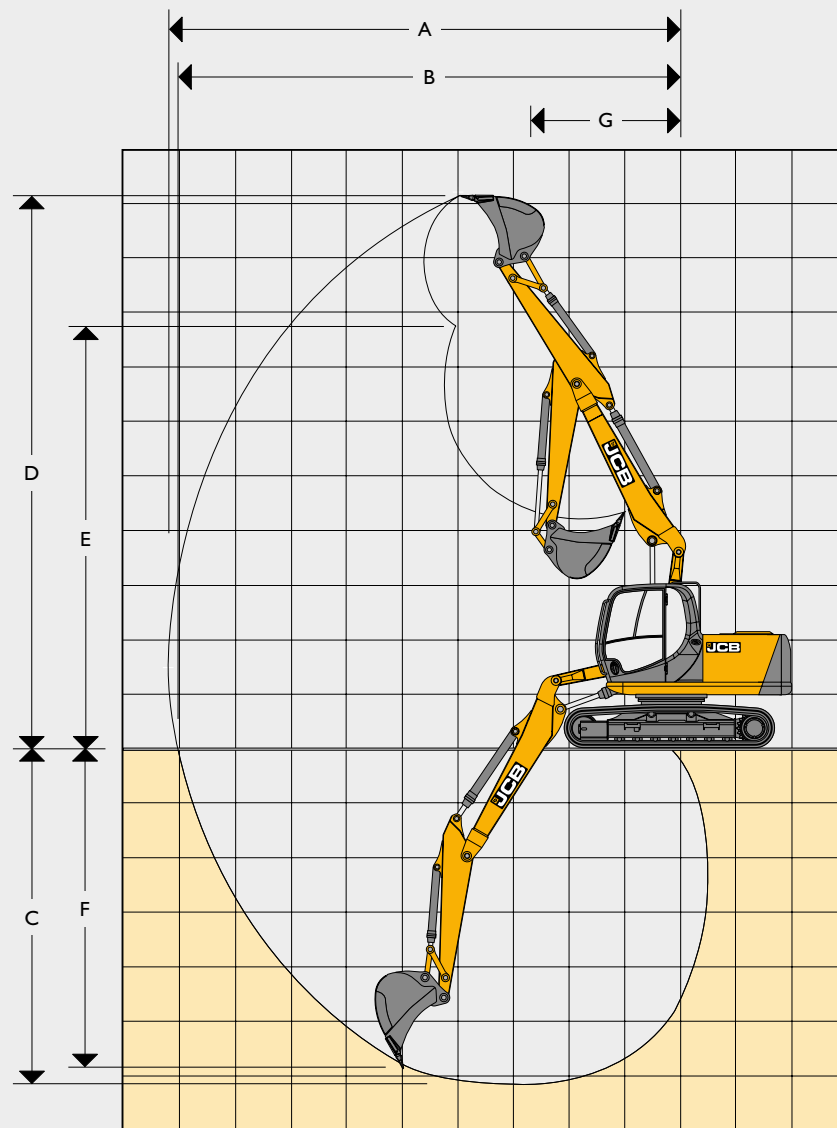







Dipper length:		2.1m	2.5m	2.7m	3.0m
A	Maximum digging reach	mm	8266	8751	8840
B	Maximum digging reach (on ground)	mm	8199	8614	8700
C	Maximum digging depth	mm	5136	5639	5754
D	Maximum digging height	mm	9375	9800	9837
E	Maximum dumping height	mm	7152	7376	7615
F	Maximum vertical wall cut depth	mm	3786	3993	4371
G	Minimum swing radius	mm	2616	2746	3031
	Bucket rotation	deg	182°	182°	182°
	Maximum dipper tearout	kNm	72.5	64.6	63.2
	Maximum bucket tearout	kNm	91.9	91.9	91.9



LIFT CAPACITIES – DIPPER LENGTH: 2.1M, 4.7M MONOBOOM, TRACKSHOES: 500MM, NO BUCKET JSI30 LC MONO

Reach	3m		4m		5m		6m		Capacity at Max Reach		mm
											
Load Point Ht.	kg	kg	kg	kg	kg	kg	kg	kg	kg	kg	mm
6.0m			3230*	3230*	3220*	3220			2960*	2960*	5044
5.0m			3380*	3380*	3340*	3240			2760*	2540	5792
4.0m	4520*	4520*	3890*	3890*	3560*	3170	3370	2390	2680*	2200	6293
3.0m	6160*	6160*	4640*	4280	3950*	3080	3330	2340	2680*	2010	6603
2.0m			5450*	4070	4290	2970	3270	2290	2740	1920	6750
1.0m			5890	3920	4190	2880	3210	2240	2710	1890	6745
0m	6120*	5880	5780	3830	4120	2810	3170	2200	2780	1940	6587
- 1.0m	8490*	5880	5750	3800	4090	2790	3160	2190	2980	2070	6264
- 2.0m	7950*	5920	5760	3810	4100	2790			3380	2340	5749
- 3.0m	6990*	6020	5410*	3870					4040*	2880	4979

LIFT CAPACITIES – DIPPER LENGTH: 2.5M, 4.7M MONOBOOM, TRACKSHOES: 500MM, NO BUCKET JSI30 LC MONO

Reach	3m		4m		5m		6m		Capacity at Max Reach		mm
											
Load Point Ht.	kg	kg	kg	kg	kg	kg	kg	kg	kg	kg	mm
6.0m			2800*	2800*	3010*	3010*			2370*	2370*	5533
5.0m			2980*	2980*	3020*	3020*	3110*	2430	2240*	2240*	6221
4.0m	3860*	3860*	3490*	3490*	3270*	3210	3170*	2410	2190	2010	6689
3.0m	5400*	5400*	4250*	4250*	3680*	3110	3350	2360	2190*	1850	6982
2.0m	7130*	6310	5100*	4120	4150*	2990	2380	2290	2250*	1770	7121
1.0m	6370*	5990	5810*	3940	4200	2880	3210	2580	2360	1740	7116
0m	6830*	5860	5780	3820	4120	2810	3160	2180	2540*	1780	6967
- 1.0m	8630*	5820	5720	3770	4070	2760	3130	2160	2710	1880	6663
- 2.0m	8240*	5850	5720	3770	4060	2760	4140	2170	3020	2090	6181
- 3.0m	7460*	5930	5370*	3810	4100	2790			3620	2490	5474

LIFT CAPACITIES – DIPPER LENGTH: 2.7M, 4.7M MONOBOOM, TRACKSHOES: 500MM, NO BUCKET JSI30 LC MONO

Reach	3m		4m		5m		6m		Capacity at Max Reach		mm
											
Load Point Ht.	kg	kg	kg	kg	kg	kg	kg	kg	kg	kg	mm
6.0m					2840*	2840*			2530*	2530*	5653
5.0m			2720*	2720*	2720*	2820*	2950*	2440	2390*	2240	6326
4.0m			3150*	3150*	3040*	3040*	3000*	2380	2330*	1960	6785
3.0m	4660*	4660*	3830*	3830*	3410*	2970	3190*	2290	2320*	1800	7075
2.0m	6270*	5680	4620*	3820	3850*	2830	3150	2210	2380*	1710	7210
1.0m	7520*	5440	5330*	3640	3940	2710	3070	2130	2400	1670	7205
0m	8090*	5340	5290	3520	3840	2630	3000	2070	2430	1690	7060
- 1.0m	8130*	5290	5230	3470	3790	2580	2970	2040	2560	1770	6759
- 2.0m	7800*	5270	5210	3450	3770	2560	2970	2040	2810	1940	6287
- 3.0m	7110*	5280	5240	3480	3810	2590			3300	2270	5592

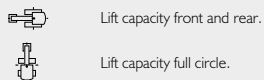



- Notes:
1. For lifting capacity including bucket, subtract total weight of bucket or bucket and quickhitch from above values.
 2. Lifting capacities are based on ISO 10567, that is: 75% of minimum tipping load or 87% of hydraulic lift capacity, whichever is the less. Lifting capacities marked* are based on hydraulic capacity.
 3. Lift capacities assume that the machine is on firm, level ground.
 4. Lift capacities may be limited by local regulations. Please refer to your dealer.











LIFT CAPACITIES – DIPPER LENGTH: 3.0M, 4.7M MONOBOOM, TRACKSHOES: 500MM, NO BUCKET. JS130 LC MONO

Reach	3m		4m		5m		6m		Capacity at Max Reach		mm
											
Load Point Ht.	kg	kg	kg	kg	kg	kg	kg	kg	kg	kg	mm
6.0m					2540*	2540*	2520*	2460	2180*	2180*	6113
5.0m					2610*	2610*	2720*	2470	2070*	2010*	6741
4.0m			2960*	2960*	2890*	2890*	2840*	2430	2030*	1790	7175
3.0m	4460*	4460*	3710*	3710*	3310*	3140	3080*	2370	2040*	1660	7448
2.0m	6210*	6210*	4600*	4180	3820*	3010	3280	2290	2090*	1590	7578
1.0m	7640*	6060	5410*	3960	4210	2880	3200	2220	2190*	1570	7574
0m	7510*	5830	5770	3810	4100	2780	3140	2160	2300	1590	7434
- 1.0m	8610*	5740	5670	3720	4030	2720	3090	2120	2420	1670	7150
- 2.0m	8430*	5730	5640	3690	4000	2700	3080	2100	2650	1820	6704
- 3.0m	7880*	5780	5660	3710	4020	2710	3110	2130	3070*	2110	6060

LIFT CAPACITIES – DIPPER LENGTH: 2.1M, 4.7M MONOBOOM, TRACKSHOES: 500MM, NO BUCKET, DOZER. JS130 LC MONO

Reach	3m		4m		5m		6m		Capacity at Max Reach		mm
											
Load Point Ht.	kg	kg	kg	kg	kg	kg	kg	kg	kg	kg	mm
6.0m			3230*	3230*	3220*	3220*			2960*	2960*	5044
5.0m			3380*	3380*	3340*	3340*			2760*	2650	5792
4.0m	4520*	4520*	3890*	3890*	3560*	3320	3440*	2500	2680*	2310	6293
3.0m	6160*	6160*	4640*	4470	3950*	3220	3590*	2460	2680*	2120	6603
2.0m			5450*	4260*	4390*	3110	3550	2400	2760*	2020	6750
1.0m			6070*	4110	4560	3020	3500	2350	2900*	1990	6745
0m	6120*	6120*	6310	4020	4490	2960	3460	2310	3040	2040	6587
- 1.0m	8490*	6170	6270	3990	4460	2930	3440	2300	3250	2180	6264
- 2.0m	7950*	6210	6120*	4000	4470	2940			3680	2460	5749
- 3.0m	6990*	6310	5410*	4060					4040*	3030	4979

LIFT CAPACITIES – DIPPER LENGTH: 2.5M, 4.7M MONOBOOM, TRACKSHOES: 500MM, NO BUCKET, DOZER. JS130 LC MONO

Reach	3m		4m		5m		6m		Capacity at Max Reach		mm
											
Load Point Ht.	kg	kg	kg	kg	kg	kg	kg	kg	kg	kg	mm
6.0m			2800*	2800*	3010*	3010*			2370*	2370*	5533
5.0m			2980*	2980*	3020*	3020*	3110*	2540	2240*	2240*	6221
4.0m	3860*	3860*	3490*	3490*	3270*	3270*	3170*	2520	2190*	2110	6689
3.0m	5400*	5400*	4250*	4250*	3680*	3250	3370*	2470	2190*	1940	6982
2.0m	7130*	6600	5100*	4310	4150*	3130	3560	2410	2250*	1860	7121
1.0m	6370*	6280	5810*	4130	4570	3030	3500	2350	2360*	1840	7116
0m	6830*	6140	6260	4010	4480	2950	3440	2300	2540*	1870	6967
- 1.0m	8630*	6110	6240	3960	4440	2900	3420	2270	2840*	1980	6663
- 2.0m	8240*	6140	6240	3960	4430	2900	3420	2280	3290	2200	6181
- 3.0m	7460*	6210	5370*	4000	4460*	2940			3850*	2620	5474



Lift capacity front and rear.



Lift capacity full circle.



Notes:

1. For lifting capacity including bucket, subtract total weight of bucket or bucket and quickhitch from above values.
2. Lifting capacities are based on ISO 10567, that is: 75% of minimum tipping load or 87% of hydraulic lift capacity, whichever is the less. Lifting capacities marked* are based on hydraulic capacity.
3. Lift capacities assume that the machine is on firm, level ground.
4. Lift capacities may be limited by local regulations. Please refer to your dealer.









LIFT CAPACITIES – DIPPER LENGTH: 2.7M, 4.7M MONOBOOM, TRACKSHOES: 500MM, NO BUCKET, DOZER. JSI30 LC MONO

Reach	3m		4m		5m		6m		Capacity at Max Reach		mm
											
Load Point Ht.	kg	kg	kg	kg	kg	kg	kg	kg	kg	kg	mm
6.0m					2840*	2840*			2530*	2530*	5653
5.0m			2720*	2720*	2820*	2820*	2950*	2560	2390*	2350	6326
4.0m			3150*	3150*	3040*	3040*	3000*	2490	2330*	2060	6785
3.0m	4660*	4660*	3830*	3830*	3410*	3110	3190*	2400	2320*	1890	7075
2.0m	6270*	5940	4620*	4000	3850*	2960	3430	2320	2380*	1800	7210
1.0m	7520*	5700	5330*	3810	4270*	2840	3340	2240	2490*	1760	7205
0m	8090*	5600	5770	3700	4190	2760	3270	2180	2650*	1780	7060
- 1.0m	8130*	5550	5710	3460	4130	2710	3240	2150	2790	1860	6759
- 2.0m	7800*	5530	5690	3630	4120	2700	3240	2150	3070	2040	6287
- 3.0m	7110*	5540	5490*	3650	4150	2730			3600	2390	5592

LIFT CAPACITIES – DIPPER LENGTH: 3.0M, 4.7M MONOBOOM, TRACKSHOES: 500MM, NO BUCKET, DOZER. JSI30 LC MONO

Reach	3m		4m		5m		6m		Capacity at Max Reach		mm
											
Load Point Ht.	kg	kg	kg	kg	kg	kg	kg	kg	kg	kg	mm
6.0m					2540*	2540*	2520*	2520*	2180*	2180*	6113
5.0m					2610*	2610*	2720*	2580	2070*	2070*	6741
4.0m			2960*	2960*	2890*	2890*	2840*	2540	2030	1880	7175
3.0m	4460*	4460*	3710*	3710*	3310*	3280	3080*	2480	2040*	1750	7448
2.0m	6210*	6210*	4600*	4370	3820*	3150	3380*	2410	2090*	1680	7578
1.0m	7640*	6350	5410*	4150	4310*	3020	3490	2330	2190*	1650	7574
0m	7510*	6120	5990*	4000	4470	2930	3420	2270	2350*	1680	7434
- 1.0m	8610*	6030	6200*	3910	4400	2860	3380	2230	2590*	1760	7150
- 2.0m	8430*	6020	6160	3880	4370	2840	3360	2220	2890	1920	6704
- 3.0m	7880*	6070	5970*	3900	4380	2850			3350	2220	6060

LIFT CAPACITIES – DIPPER LENGTH: 2.1M, 4.7M MONOBOOM, TRACKSHOES: 500MM, NO BUCKET. JSI45 LC MONO



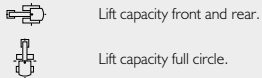



Reach	3m		4m		5m		6m		Capacity at Max Reach		mm
											
Load Point Ht.	kg	kg	kg	kg	kg	kg	kg	kg	kg	kg	mm
6.0m			3230*	3230*	3220*	3220*			2960*	2960*	5044
5.0m			3380*	3380*	3340*	3340*			2760*	2760*	5792
4.0m	4520*	4520*	3890*	3890*	3560*	3560*	3440*	2730	2680*	2530	6293
3.0m	6160*	6160*	4640*	4640*	3950*	3510	3590*	2690	2680*	2320	6603
2.0m			5450*	4660	4390*	3410*	3730	2640	2760*	2220	6750
1.0m			6070*	4500	4770*	3310	3670	2580	2900*	2200	6745
0m	6120*	6120*	6390*	4410	4710	3250	3630	2550	3150*	2250	6587
- 1.0m	8490*	6760	6410*	4380	4680	3220	3620	2530	3410	2400	6264
- 2.0m	7950*	6810	6120*	4390	4690	3230			3860	2700	5749
- 3.0m	6990*	6900	5410*	4460					4040*	3320	4979



- Notes:
1. For lifting capacity including bucket, subtract total weight of bucket or bucket and quickhitch from above values.
 2. Lifting capacities are based on ISO 10567, that is: 75% of minimum tipping load or 87% of hydraulic lift capacity, whichever is the less. Lifting capacities marked* are based on hydraulic capacity.
 3. Lift capacities assume that the machine is on firm, level ground.
 4. Lift capacities may be limited by local regulations. Please refer to your dealer.

LIFT CAPACITIES – DIPPER LENGTH: 2.5M, 4.7M MONOBOOM, TRACKSHOES: 500MM, NO BUCKET.

JS145 LC MONO

Reach	3m		4m		5m		6m		Capacity at Max Reach		mm
											
Load Point Ht.	kg	kg	kg	kg	kg	kg	kg	kg	kg	kg	mm
6.0m			2800*	2800*	3010*	3010*			2370*	2370*	5533
5.0m			2980*	2980*	3020*	3020*	3110*	2780	2240*	2240*	6221
4.0m	3860*	3860*	3490*	3490*	3270*	3270*	3170*	2760	2190	2190	6689
3.0m	5400*	5400*	4250*	4250*	3680*	3540	3370	2700	2190*	2140	6982
2.0m	7130*	7130	5100*	4710	4150	3420	3640*	2640	2250*	2050	7121
1.0m	6370*	6370*	5810*	4520	4560*	3320	3670	2580	2360	2030	7116
0m	6830*	6740	6260	4410	4710	3240	3620	2530	2540*	2070	6967
- 1.0m	8630*	6710	6400*	4350	4660	3200	2590	2500	2840*	2190	6663
- 2.0m	8240*	6730	6240*	4350	4650	3190	3600	2510	3340*	2420	6181
- 3.0m	7460*	6810	5370*	4390	4460*	3230			3850*	2880	5474

LIFT CAPACITIES – DIPPER LENGTH: 2.7M, 4.7M MONOBOOM, TRACKSHOES: 500MM, NO BUCKET.

JS145 LC MONO

Reach	3m		4m		5m		6m		Capacity at Max Reach		mm
											
Load Point Ht.	kg	kg	kg	kg	kg	kg	kg	kg	kg	kg	mm
6.0m					2840*	2840*			2530*	2530*	4666
5.0m			2720*	2720*	2820*	2820*	2950*	2790	2390*	2390*	6326
4.0m			3150*	3150*	3040*	3040*	3000*	2720	2330*	2260	6785
3.0m	4660*	4660*	3830*	3830*	3410*	3390	3190*	2630	2320*	2080	7075
2.0m	6270*	6270*	4620*	4360	3850*	3240	3430*	2540	2910	2060	7210
1.0m	7520*	6240	5330*	4180	4270*	3120	3500	2470	2490*	1940	7205
0m	8090*	6150	5810*	4070	4400	3040	3440	2410	2650*	1970	7060
- 1.0m	8130*	6100	5990	4010	4340	2990	3400	2370	2940	2060	6759
- 2.0m	7800*	6070	5910*	3990	4330	2970	3410	2380	3220	2260	6287
- 3.0m	7110*	6080	5490*	4020	4360	3010			3750*	2630	5592

LIFT CAPACITIES – DIPPER LENGTH: 3.0M, 4.7M MONOBOOM, TRACKSHOES: 500MM, NO BUCKET.

JS145 LC MONO

Reach	3m		4m		5m		6m		Capacity at Max Reach		mm
											
Load Point Ht.	kg	kg	kg	kg	kg	kg	kg	kg	kg	kg	mm
6.0m					2540*	2540*	2520*	2520*	2180*	2180*	6113
5.0m					2610*	2610*	2720*	2720	2070*	2070*	6741
4.0m			2960*	2960*	2890*	2890*	2840*	2780	2030	2030	7175
3.0m	4460*	4460*	3710*	3710*	3310*	3310	3080	2720	2040*	1930	7448
2.0m	6210*	6210*	4600*	4600*	3820*	3440	3380*	2640	2090*	1850	7578
1.0m	7640*	6940	5410*	4540	4310*	3320	3660	2570	2190	1830	7574
0m	7510*	6710	5990*	4390	4690	3220	3590	2500	2350*	1860	7434
- 1.0m	8610*	6620	6280*	4300	4620	3160	3550	2460	2590*	1950	7150
- 2.0m	8430*	6620	6280*	4270	4590	3130	3540	2450	2990*	2130	6704
- 3.0m	7880*	6670	5970*	4300	4610*	3140	3570	2480	3520*	2450	6060



Lift capacity front and rear.

Notes:

1. For lifting capacity including bucket, subtract total weight of bucket or bucket and quickhitch from above values.
2. Lifting capacities are based on ISO 10567, that is: 75% of minimum tipping load or 87% of hydraulic lift capacity, whichever is the less. Lifting capacities marked* are based on hydraulic capacity.
3. Lift capacities assume that the machine is on firm, level ground.
4. Lift capacities may be limited by local regulations. Please refer to your dealer.













Lift capacity full circle.

LIFT CAPACITIES – DIPPER LENGTH: 2.1M, 4.7M MONOBOOM, TRACKSHOES: 500MM, NO BUCKET, DOZER. JSI45 LC MONO

Reach	3m		4m		5m		6m		Capacity at Max Reach		mm
											
Load Point Ht.	kg	kg	kg	kg	kg	kg	kg	kg	kg	kg	mm
6.0m			3230*	3230*	3220*	3220*			2960*	2960*	5044
5.0m			3380*	3380*	3340*	3340*			2760*	2760*	5792
4.0m	4520*	4520*	3890*	3890*	3560*	3560*	3440*	2840	2680*	2630	6293
3.0m	6160*	6160*	4640*	4640*	3950*	3650	3590*	2800	2680*	2420	6603
2.0m			5450*	4840	4390*	3550	3820*	2750	2760*	2320	6750
1.0m			6070*	4690	4770*	3450	3900	2690	2900*	2290	6745
0m	6120*	6120*	6390*	4600	5000	3390	3860	2660	3150*	2350	6587
- 1.0m	8490*	7050	6410*	4570	4970	3360	3840	2640	3550*	2510	6264
- 2.0m	7950*	7090	6120*	4580	4840*	3370			3990*	2820	5749
- 3.0m	6990*	6990*	5410*	4640					4040*	3460	4979

LIFT CAPACITIES – DIPPER LENGTH: 2.5M, 4.7M MONOBOOM, TRACKSHOES: 500MM, NO BUCKET, DOZER. JSI45 LC MONO

Reach	3m		4m		5m		6m		Capacity at Max Reach		mm
											
Load Point Ht.	kg	kg	kg	kg	kg	kg	kg	kg	kg	kg	mm
6.0m			2850*	2850*	2880*	2880*	2850*	2850*	2460*	2460*	6064
5.0m			3100*	3100*	2980*	2980*	2930*	2870	2290*	2290*	6698
4.0m	4290*	4290*	3630*	3630*	3260*	3260*	3050*	2830	2210*	2130	7134
3.0m			4360*	4360*	3660*	3610	3260*	2760	2180*	1990	7409
2.0m			5140*	4750	4100*	3470	3520*	2680	2200*	1910	7540
1.0m			5750*	4550	4490*	3350	3760*	2610	2270*	1890	7535
0m			6090*	4430	4750*	3270	3780	2560	2390*	1930	7394
- 1.0m	5800*	5800*	6160*	4390	4850*	3230	3750	2530	2590*	2040	7109
- 2.0m	7790*	6840	5980*	4400	4750*	3220	3760	2530	2900*	2240	6660

LIFT CAPACITIES – DIPPER LENGTH: 3.0M, 4.7M MONOBOOM, TRACKSHOES: 500MM, NO BUCKET, DOZER. JSI45 LC MONO

Reach	3m		4m		5m		6m		Capacity at Max Reach		mm
											
Load Point Ht.	kg	kg	kg	kg	kg	kg	kg	kg	kg	kg	mm
6.0m					2730*	2730*	2880*	2880*	2620*	2620*	6218
5.0m			2840*	2840*	2790*	2790*	2790*	2790*	2460*	2330	6834
4.0m	3720*	3720*	3280*	3280*	3030*	3030*	2890*	2780	2360*	2080	7263
3.0m			3940*	3940*	3390*	3390*	3080*	2680	2310*	1930	7535
2.0m			4670*	4400	3800*	3280	3320*	2580	2330*	1840	7663
1.0m			5290*	4210	4180*	3150	3550*	2490	2390*	1810	7659
0m			5680*	4100	4460*	3060	3590	2430	2500*	1840	7521
- 1.0m	6790*	6230	5800*	4050	4530	3010	3550	2390	2700*	1920	7239
- 2.0m	7440*	6220	5670*	4050	4520	3000	3550	2390	3010*	2080	6798
- 3.0m	6760*	6230	5270*	4080	4230*	3040	3350*	2450	3170*	2380	6167

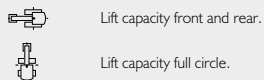

- Notes:**
1. For lifting capacity including bucket, subtract total weight of bucket or bucket and quickhitch from above values.
 2. Lifting capacities are based on ISO 10567, that is: 75% of minimum tipping load or 87% of hydraulic lift capacity, whichever is the less. Lifting capacities marked* are based on hydraulic capacity.
 3. Lift capacities assume that the machine is on firm, level ground.
 4. Lift capacities may be limited by local regulations. Please refer to your dealer.



LIFT CAPACITIES – DIPPER LENGTH: 3.0M, 4.7M MONOBOOM, TRACKSHOES: 500MM, NO BUCKET, DOZER. JSI45 LC MONO

Reach	3m		4m		5m		6m		Capacity at Max Reach		mm
											
Load Point Ht.	kg	kg	kg	kg	kg	kg	kg	kg	kg	kg	mm
6.0m					2500*	2500*	2600*	2600*	2240*	2240*	6650
5.0m					2630*	2630*	2620*	2620*	2110*	2100	7231
4.0m			3150*	3150*	2920*	2920*	2770*	2770*	2050*	1910	7636
3.0m			3880*	3880*	3330*	3330*	3010*	2780	2040*	1790	7893
2.0m			4690*	4690*	3800*	3500	3290*	2690	2060*	1730	8016
1.0m			5390*	4570	4230*	3350	3570*	2600	2110*	1710	8012
0m			5860*	4410	4570*	3240	3760	2530	2220*	1740	7880
- 1.0m	5660*	5660*	6070*	4330	4750*	3180	3710	2490	2380*	1820	7613
- 2.0m	7860*	6690	6030*	4310	4760*	3160	3700	2470	2640*	1970	7196
- 3.0m	7470*	6770	5720*	4350	4540*	3180	3640*	2500	3040*	2240	6601

LIFT CAPACITIES – DIPPER LENGTH: 2.1M, 5.0M T.A.B., TRACKSHOES: 500MM, NO BUCKET, DOZER. JSI45 LC T.A.B.

Reach	3m		4m		5m		6m		Capacity at Max Reach		mm
											
Load Point Ht.	kg	kg	kg	kg	kg	kg	kg	kg	kg	kg	mm
6.0m			3210*	3210*	3200*	3200*			3070*	3070*	5575
5.0m			3450*	3450*	3250*	3250*	3200*	2830	2830*	2630*	6259
4.0m	4910*	4910*	3980*	3980*	3510*	3510*	3260*	2810	2720*	2330	6724
3.0m			4720*	4720*	3890*	3580	3450*	2750	2680*	2160	7015
2.0m			5460*	4690	4300*	3450	3680*	2680	2700*	2070	7154
1.0m			5980*	4520	4650*	3340	3840	2610	2780*	2050	7149
0m			6190*	4440	4850*	3280	3800	2570	2940*	2100	7000
- 1.0m	5710*	5710*	6150*	4430	4880*	3250	3780	2560	3210*	2230	6697
- 2.0m	7460*	6930	5850*	4450	4680*	3270	3720*	2580	3450*	2480	6219
- 3.0m			5220*	4530	4100*	3330			3710*	3080	5322

LIFT CAPACITIES – DIPPER LENGTH: 2.5M, 5.0M T.A.B., TRACKSHOES: 500MM, NO BUCKET, DOZER. JSI45 LC T.A.B.

Reach	3m		4m		5m		6m		Capacity at Max Reach		mm
											
Load Point Ht.	kg	kg	kg	kg	kg	kg	kg	kg	kg	kg	mm
6.0m			2800*	2800*	3010*	3010*			2370*	2370*	5533
5.0m			2980*	2980*	3020*	3020*	3110*	2890	2240*	2240*	6221
4.0m	3860*	3860*	3490*	3490*	3270*	3270*	3170*	2870	2190*	2190*	6689
3.0m	5400*	5400*	4250*	4250*	3680*	3680	3370*	2820	2190*	2190*	6982
2.0m	7130*	7130*	5100*	4890	4150*	3560*	3640*	2750	2250*	2140	7121
1.0m	6370*	6370*	5810*	4710	4590*	3460	3890*	2690	2360*	2120	7116
0m	6830*	6830*	6260*	4600	4900*	3380	3840	2640	2540*	2160	6967
- 1.0m	8630*	6990	6400*	4540	4950	3340	3820	2620	2840*	2280	6663
- 2.0m	8240*	7020	6240*	4540	4940	3330	3820	2620	3340*	2530	6181
- 3.0m	7460*	7090	5730*	4580	4460*	3370			3850*	3000	5474

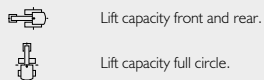

- Notes:
1. For lifting capacity including bucket, subtract total weight of bucket or bucket and quickhitch from above values.
 2. Lifting capacities are based on ISO 10567, that is: 75% of minimum tipping load or 87% of hydraulic lift capacity, whichever is the less. Lifting capacities marked* are based on hydraulic capacity.
 3. Lift capacities assume that the machine is on firm, level ground.
 4. Lift capacities may be limited by local regulations. Please refer to your dealer.











LIFT CAPACITIES – DIPPER LENGTH: 2.7M, 5.0M T.A.B., TRACKSHOES: 500MM, NO BUCKET, DOZER. JSI45 LC T.A.B.

Reach	3m		4m		5m		6m		Capacity at Max Reach		mm
											
Load Point Ht.	kg	kg	kg	kg	kg	kg	kg	kg	kg	kg	mm
6.0m					2840*	2840*			2530*	2530*	5653
5.0m			2720*	2720*	2820*	2820*	2950*	2900	2390*	2390*	6326
4.0m			3150*	3150*	3040*	3040*	3000*	2830	2330*	2330*	6785
3.0m	4660*	4660*	3830*	3830*	3410*	3410*	3190*	2740	2320*	2170	7075
2.0m	6270*	6270*	4620*	4540	3850*	3380	3430*	2650	2380*	2070	7210
1.0m	7520*	6500	5330*	4350	4270*	3250	3680*	2570	2490*	2030	7205
0m	8090*	6410	5810*	4240	4600*	3170	3660	2510	2650*	2060	7060
- 1.0m	8130*	6360	6000*	4180	4620	3120	3620	2480	2490*	2160	6759
- 2.0m	7800*	6330	5910*	4170	4600	3110	3630	2480	3390*	2360	6287
- 3.0m	7110*	6340	5490*	4190	4360*	3140			3750*	2750	5592

LIFT CAPACITIES – DIPPER LENGTH: 3.0M, 5.0M T.A.B., TRACKSHOES: 500MM, NO BUCKET, DOZER. JSI45 LC T.A.B.

Reach	3m		4m		5m		6m		Capacity at Max Reach		mm
											
Load Point Ht.	kg	kg	kg	kg	kg	kg	kg	kg	kg	kg	mm
6.0m					2540*	2540*	2520*	2520*	2180*	2180*	6113
5.0m					2610*	2610*	2720*	2720*	2070*	2070*	6741
4.0m			2960*	2960*	2890*	2890*	2840*	2840*	2030*	2030*	7175
3.0m	4460*	4460*	3710*	3710*	3310*	3310*	3080*	2830	2040*	2020	7448
2.0m	6210*	6210*	4600*	4600*	3820*	3580	3380*	2750	2090*	1940	7578
1.0m	7640*	7230	5410*	4730	4310*	3460	3680*	2680	2190*	1910	7574
0m	7510*	7000	5990*	4580	4700*	3360	3820	2620	2350*	1940	7434
- 1.0m	8610*	6910	6280*	4490	4910	3300	3780	2570	2590*	2040	7150
- 2.0m	8430*	6900	6280*	4460	4880	3270	3760	2560	2990*	2220	6704
- 3.0m	7880*	6950	5970*	4480	4700*	3280	3670	2590	3590*	2560	6060

LIFT CAPACITIES – DIPPER LENGTH: 2.1M, 5.0M T.A.B., TRACKSHOES: 500MM, NO BUCKET. JSI45 LC T.A.B.

Reach	3m		4m		5m		6m		Capacity at Max Reach		mm
											
Load Point Ht.	kg	kg	kg	kg	kg	kg	kg	kg	kg	kg	mm
6.0m			3210*	3210*	3200*	3200*			3070*	3040	5575
5.0m			3450*	3450*	3250*	3250*		2720	2830*	2520	6259
4.0m	4910*	4910*	3980*	3980*	3510*	3510*	3260*	2700	2720*	2230	6724
3.0m			4720*	4720*	3890*	3440	3450*	2630	2680*	2060	7015
2.0m			5460*	4500	4300*	3310	3680	2560	2700*	1980	7154
1.0m			5980*	4340	4650*	3200	3610	2500	2780*	1960	7149
0m			6190*	4260	4630	3140	3570	2460	2890	2010	7000
- 1.0m	5710*	5710*	6150*	4240	4600	3110	3550	2450	3070	2130	6697
- 2.0m	7460*	6650	5850*	4270	4610	3130	3580	2470	3430	2380	6219
- 3.0m			5220*	4340	4100*	3190			3710*	2950	5322

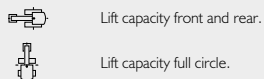











- Notes:
1. For lifting capacity including bucket, subtract total weight of bucket or bucket and quickhitch from above values.
 2. Lifting capacities are based on ISO 10567, that is: 75% of minimum tipping load or 87% of hydraulic lift capacity, whichever is the less. Lifting capacities marked* are based on hydraulic capacity.
 3. Lift capacities assume that the machine is on firm, level ground.
 4. Lift capacities may be limited by local regulations. Please refer to your dealer.

LIFT CAPACITIES – DIPPER LENGTH: 2.5M, 5.0M T.A.B., TRACKSHOES: 500MM, NO BUCKET. JSI45 LC T.A.B.

Reach	3m		4m		5m		6m		Capacity at Max Reach		mm
											
Load Point Ht.	kg	kg	kg	kg	kg	kg	kg	kg	kg	kg	
6.0m			2850*	2850*	2880*	2880*	2850*	2740	2460*	2460*	6064
5.0m			3100*	3100*	2980*	2980*	2930*	2760	2290*	2280	6698
4.0m	4290*	4290*	3630*	3630*	3260*	3260*	3050*	2720	2210*	2040	7134
3.0m			4360*	4360*	3660*	3470	3260*	2650	2180*	1900	7409
2.0m			5140*	4560	4100*	3330	3520*	2570	2200*	1830	7540
1.0m			5750*	4360	4480*	3210	3890*	2690	2360*	2120	7116
0m			6090*	4250	4620	3130	3550	2450	2390*	1850	7394
- 1.0m	5800*	5800*	6160*	4200	4570	3090	3520	2420	2590*	1950	7109
- 2.0m	7790*	6550	5980*	4210	4570	3080	3530	2420	2900*	2140	6660
- 3.0m	7050*	6650	5500*	4270	4370*	3130	3260*	2490	3240*	2490	6011

LIFT CAPACITIES – DIPPER LENGTH: 2.7M, 5.0M T.A.B., TRACKSHOES: 500MM, NO BUCKET. JSI45 LC T.A.B.

Reach	3m		4m		5m		6m		Capacity at Max Reach		mm
											
Load Point Ht.	kg	kg	kg	kg	kg	kg	kg	kg	kg	kg	
6.0m					2730*	2730*	2880*	2810	2620*	2620*	6218
5.0m			2840*	2840*	2790*	2790*	2790*	2760	2460*	2230	6834
4.0m	3720*	3720*	3280*	3280*	3030*	3030*	2890*	2670	2360*	1990	7263
3.0m			3940*	3940*	3390*	3310	3080*	2570	2310*	1840	7535
2.0m			4670*	4230	3800*	3150	3320*	2470	2330*	1760	7663
1.0m			5290*	4040	4180*	3020	3440	2380	2390*	1730	7659
0m			5680*	3930	4310	2930	3370	2320	2500*	1750	7521
- 1.0m	6790*	5970	5800*	3880	4260	2880	3330	2280	2650	1830	7239
- 2.0m	7440*	5950	5670*	3870	4250	2870	3330	2280	2880	1990	6798
- 3.0m	6760*	5970	5270*	3910	4230*	2900	3350*	2340	3160*	2280	6167

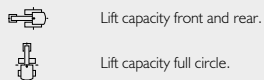

LIFT CAPACITIES – DIPPER LENGTH: 3.0M, 5.0M T.A.B., TRACKSHOES: 500MM, NO BUCKET. JSI45 LC T.A.B.

Reach	3m		4m		5m		6m		Capacity at Max Reach		mm
											
Load Point Ht.	kg	kg	kg	kg	kg	kg	kg	kg	kg	kg	
6.0m					2500*	2500*	2600*	2600*	2240*	2240*	6650
5.0m					2630*	2630*	2620*	2620*	2110*	2020	7231
4.0m			3150*	3150*	2920*	2920*	2770*	2750	2050*	1830	7636
3.0m			3880*	3880*	3330*	3330*	3010*	2670	2040*	1710	7893
2.0m			4690*	4630	3800*	3360	3290*	2570	2060*	1650	8016
1.0m			5390*	4380	4230*	3210	3570*	2490	2110*	1630	8012
0m			5860*	4220	4570*	3100	3530	2420	2220*	1650	7880
- 1.0m	5660*	5660*	6070*	4140	4530	3040	3480	2370	2380*	1730	7613
- 2.0m	7860*	6410	6030*	4130	4500	3020	3470	2360	2640*	1880	7196
- 3.0m	7470*	6490	5720*	4160	4530	3040	3500	2390	3040*	2140	6601







- Notes:
1. For lifting capacity including bucket, subtract total weight of bucket or bucket and quickhitch from above values.
 2. Lifting capacities are based on ISO 10567, that is: 75% of minimum tipping load or 87% of hydraulic lift capacity, whichever is the less. Lifting capacities marked* are based on hydraulic capacity.
 3. Lift capacities assume that the machine is on firm, level ground.
 4. Lift capacities may be limited by local regulations. Please refer to your dealer.







LIFT CAPACITIES – DIPPER LENGTH: 2.1M, 4.7M MONOBOOM, TRACKSHOES: 600MM, NO BUCKET. JSI45 HD MONO

Reach	3m		4m		5m		6m		Capacity at Max Reach		mm
											
Load Point Ht.	kg	kg	kg	kg	kg	kg	kg	kg	kg	kg	mm
6.0m			3230*	3230*	3420*	3420*			2940*	2940*	5122
5.0m			3420*	3420*	3350*	3350*			2750*	2750*	5845
4.0m	4650*	4650*	3950*	3950*	3590*	3590*	3440*	3170	2680*	2680*	6327
3.0m	6320*	6320*	4710*	4710*	3990*	3990*	3610*	3130	2690*	2690*	6622
2.0m			5510*	5480	4420*	3980	3840*	3070	2760*	2590	6756
1.0m			6110*	5320	4800*	3880	4050*	3020	2920*	2570	6737
0m	6340*	6340*	6400*	5240	5030*	3820	4170*	2980	3180*	2650	6565
- 1.0m	8460*	8210	6400*	5210	5060*	3800	4110*	2970	3600*	2840	6227
- 2.0m	7880*	7880*	6080*	5230	4800*	3810			4000*	3210	5692
- 3.0m	6870*	6870*	5310*	5300					4040*	4000	4896

LIFT CAPACITIES – DIPPER LENGTH: 2.5M, 4.7M MONOBOOM, TRACKSHOES: 600MM, NO BUCKET. JSI45 HD MONO

Reach	3m		4m		5m		6m		Capacity at Max Reach		mm
											
Load Point Ht.	kg	kg	kg	kg	kg	kg	kg	kg	kg	kg	mm
6.0m			2800*	2800*	2990*	2990*			2360*	2360*	5604
5.0m			3020*	3020*	3030*	3030*	3110*	3110*	2230*	2230*	6271
4.0m	3980*	3980*	3550*	3550*	3300*	3300*	3180*	3180*	2180*	2180*	6722
3.0m	5560*	5560*	4320*	4320*	3720*	3720*	3400*	3140	2190*	2190*	7000
2.0m	7260*	7260*	5170*	5170*	4200*	4000	3660*	3080	2250*	2250*	7126
1.0m	6300*	6300*	5860*	5350	4620*	3890	3920*	3010	2370*	2370	7109
0m	6960*	6960*	6280*	5230	4920*	3810	4090*	2970	2570*	2430	6946
- 1.0m	8610*	8150	6400*	5180	5040*	3770	4140*	2940	2870*	2580	6628
- 2.0m	8190*	8180	6210*	5180	4910*	3770	3910*	2950	3390*	2880	6129
- 3.0m	7370*	7370*	5660*	5230	4390*	3810			3860*	2450	5398

LIFT CAPACITIES – DIPPER LENGTH: 2.7M, 4.7M MONOBOOM, TRACKSHOES: 600MM, NO BUCKET. JSI45 HD MONO

Reach	3m		4m		5m		6m		Capacity at Max Reach		mm
											
Load Point Ht.	kg	kg	kg	kg	kg	kg	kg	kg	kg	kg	mm
6.0m					2810*	2810*			2510*	2510*	5721
5.0m			2740*	2740*	2820*	2820*	2940*	2940*	2370*	2370*	6374
4.0m	3410*	3410*	3190*	3190*	3060*	3060*	3000*	3000*	2320*	2320*	6816
3.0m	4790*	4790*	3890*	3890*	3440*	3440*	3190*	3050	2320*	2320	7092
2.0m	6390*	6390*	4680*	4680*	3880*	3770	3440*	2950	2380*	2300	7216
1.0m	7580*	7500	5370*	4920	4300*	3650	3690*	2870	2490*	2270	7198
0m	8090*	7410	5820*	4810	4610*	3560	3880*	2810	2670*	2310	7040
- 1.0m	8100*	7360	5990*	4750	4750*	3510	3950*	2780	2970*	2430	6725
- 2.0m	7740*	7330	5870*	4740	4680*	3500	3820*	2790	3440*	2670	6237
- 3.0m	7020*	7020*	5420*	4770	4290*	3540			3740*	3150	5519

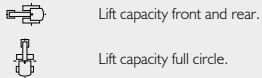











- Notes:
1. For lifting capacity including bucket, subtract total weight of bucket or bucket and quickhitch from above values.
 2. Lifting capacities are based on ISO 10567, that is: 75% of minimum tipping load or 87% of hydraulic lift capacity, whichever is the less. Lifting capacities marked* are based on hydraulic capacity.
 3. Lift capacities assume that the machine is on firm, level ground.
 4. Lift capacities may be limited by local regulations. Please refer to your dealer.







LIFT CAPACITIES – DIPPER LENGTH: 3.0M, 4.7M MONOBOOM, TRACKSHOES: 600MM, NO BUCKET. JSI45 HD MONO

Reach	3m		4m		5m		6m		Capacity at Max Reach		mm
											
Load Point Ht.	kg	kg	kg	kg	kg	kg	kg	kg	kg	kg	mm
6.0m					2530*	2530*	2660*	2660*	2170*	2170*	6117
5.0m					2630*	2630*	2720*	2720*	2070*	2070*	6786
4.0m			3020*	3020*	2920*	2920*	2860*	2860*	2030*	2030*	7205
3.0m	4610*	4610*	3790*	3790*	3360*	3360*	3110*	3110*	2040*	2040*	7465
2.0m	6360*	6360*	4680*	4680*	3860*	3860*	3410*	3080	2100*	2100*	7583
1.0m	7730*	7730*	5470*	5370	4350*	3890	3700*	3000	2200*	2150	7567
0m	7550*	7550*	6030*	5210	4730*	3790	3940*	2940	2360*	2190	7415
- 1.0m	8610*	8060	6290*	5130	4940*	3730	4070*	2900	2620*	2310	7118
- 2.0m	8400*	8060	6270*	5100	4940*	3700	4020*	2890	3030*	2530	6656
- 3.0m	7810*	7810*	5920*	5130	4660*	3720			3030*	2530	6656

LIFT CAPACITIES – DIPPER LENGTH: 2.1M, 5.0M T.A.B., TRACKSHOES: 600MM, NO BUCKET. JSI45 HD T.A.B.

Reach	3m		4m		5m		6m		Capacity at Max Reach		mm
											
Load Point Ht.	kg	kg	kg	kg	kg	kg	kg	kg	kg	kg	mm
6.0m			3220*	3220*	3190*	3190*			3050*	3050*	5645
5.0m	3880*	3880*	3490*	3490*	3260*	3260*	3200*	3180	2830*	2830*	6307
4.0m	5040*	5040*	4040*	4040*	3540*	3540*	3270*	3140	2720*	2590	6756
3.0m			4790*	4790*	3930*	3930*	3470*	3080	2680*	2410	7033
2.0m			5510*	5330	4340*	3890	3700*	3010	2700*	2330	7159
1.0m			6010*	5170	4670*	3780	3900*	2940	2800*	2320	7141
0m			6200*	5090	4860*	3720	4010*	2900	2950*	2380	6980
- 1.0m	6010*	6010*	6130*	5080	4870*	3690	3990*	2890	3220*	2540	6663
- 2.0m	7400*	7400*	5810*	5110	4650*	3710	3670*	2930	3450*	2840	6167
- 3.0m			5140*	5140*	4010*	3790			3850*	3660	5131

LIFT CAPACITIES – DIPPER LENGTH: 2.5M, 5.0M T.A.B., TRACKSHOES: 600MM, NO BUCKET. JSI45 HD T.A.B.

Reach	3m		4m		5m		6m		Capacity at Max Reach		mm
											
Load Point Ht.	kg	kg	kg	kg	kg	kg	kg	kg	kg	kg	mm
6.0m			2860*	2860*	2880*	2880*	3010*	3010*	2430*	2430*	6130
5.0m			3140*	3140*	2990*	2990*	2930*	2930*	2290*	2290*	6743
4.0m	4410*	4410*	3680*	3680*	3290*	3290*	3060*	3060*	2210*	2210*	7164
3.0m			4430*	4430*	3700*	3700*	3290*	3100	2180*	2180*	7426
2.0m			5200*	5200*	4130*	3910	3540*	3020	2210*	2150	7545
1.0m			5790*	5190	4510*	3790	3780*	2940	2280*	2140	7528
0m			6110*	5080	4770*	3710	3940*	2890	2410*	2190	7375
- 1.0m	6020*	6020*	6150*	5040	4850*	3670	3990*	2860	2610*	2310	7076
- 2.0m	7740*	7740*	5950*	5050	4730*	3670	3840*	2870	2930*	2550	6612
- 3.0m	6970*	6970*	5440*	5120	4310*	3720			3270*	3000	5922

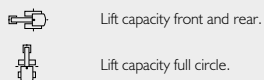

- Notes:
1. For lifting capacity including bucket, subtract total weight of bucket or bucket and quickhitch from above values.
 2. Lifting capacities are based on ISO 10567, that is: 75% of minimum tipping load or 87% of hydraulic lift capacity, whichever is the less. Lifting capacities marked* are based on hydraulic capacity.
 3. Lift capacities assume that the machine is on firm, level ground.
 4. Lift capacities may be limited by local regulations. Please refer to your dealer.

LIFT CAPACITIES – DIPPER LENGTH: 2.7M, 5.0M T.A.B., TRACKSHOES: 600MM, NO BUCKET. JSI45 HD T.A.B.

Reach	3m		4m		5m		6m		Capacity at Max Reach		mm
											
Load Point Ht.	kg	kg	kg	kg	kg	kg	kg	kg	kg	kg	mm
6.0m					2710*	2710*	2840*	2840*	2590*	2590*	6281
5.0m			2860*	2860*	2790*	2790*	2780*	2780*	2430*	2430*	6879
4.0m	3810*	3810*	3330*	3330*	3050*	3050*	2890*	2890*	2350*	2310	7292
3.0m			3990*	3990*	3410*	3410*	3090*	2990	2300*	2150	7552
2.0m			4720*	4720*	3820*	3680	3330*	2880	2330*	2060	7668
1.0m			5330*	4790	4200*	3550	3560*	2790	2390*	2040	7652
0m			5680*	4680	4460*	3460	3730*	2730	2500*	2070	7503
- 1.0m	7000*	7000*	5780*	4630	4580*	3410	3800*	2700	2720*	2170	7207
- 2.0m	7380*	7240	5630*	4630	4500*	3410	3700*	2700	3040*	2370	6751
- 3.0m	6660*	6660*	5210*	4670	4170*	3450	3270*	2770	3150*	2720	6101

LIFT CAPACITIES – DIPPER LENGTH: 3.0M, 5.0M T.A.B., TRACKSHOES: 600MM, NO BUCKET. JSI45 HD T.A.B.

Reach	3m		4m		5m		6m		Capacity at Max Reach		mm
											
Load Point Ht.	kg	kg	kg	kg	kg	kg	kg	kg	kg	kg	mm
6.0m					2500*	2500*	2600*	2600*	2240*	2240*	6650
5.0m					2630*	2630*	2620*	2620*	2110*	2020	7231
4.0m			3150*	3150*	2920*	2920*	2770*	2750	2050*	1830	7636
3.0m			3880*	3880*	3330*	3330*	3010*	2670	2040*	1710	7893
2.0m			4690*	4630	3800*	3360	3290*	2570	2060*	1650	8016
1.0m			5390*	4380	4230*	3210	3570*	2490	2110*	1630	8012
0m			5860*	4220	4570*	3100	3530	2420	2220*	1650	7880
- 1.0m	5660*	5660*	6070*	4140	4530	3040	3480	2370	2380*	1730	7613
- 2.0m	7860*	6410	6030*	4130	4500	3020	3470	2360	2640*	1880	7196
- 3.0m	7470*	6490	5720*	4160	4530	3040	3500	2390	3040*	2140	6601

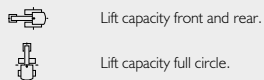

- Notes:
1. For lifting capacity including bucket, subtract total weight of bucket or bucket and quickhitch from above values.
 2. Lifting capacities are based on ISO 10567, that is: 75% of minimum tipping load or 87% of hydraulic lift capacity, whichever is the less. Lifting capacities marked* are based on hydraulic capacity.
 3. Lift capacities assume that the machine is on firm, level ground.
 4. Lift capacities may be limited by local regulations. Please refer to your dealer.







ONE COMPANY, OVER 300 MACHINES.

Your nearest JCB dealer

Tracked Excavator JS130/145 LC/HD

Engine power: 81kW (109hp) Bucket capacity: 0.35 – 0.89m³
 Operating weight: 13911 – 16627kg

JCB Sales Limited, Rokeceter, Staffordshire, United Kingdom ST14 5JP.
 Tel: +44 (0)1889 590312 Email: salesinfo@jcb.com
 Download the very latest information on this product range at: www.jcb.com

©2015 JCB Sales. All rights reserved. No part of this publication may be reproduced, stored in a retrieval system, or transmitted in any form or by any other means, electronic, mechanical, photocopying or otherwise, without prior permission from JCB Sales. All references in this publication to operating weights, sizes, capacities and other performance measurements are provided for guidance only and may vary dependant upon the exact specification of machine. They should not therefore be relied upon in relation to suitability for a particular application. Guidance and advice should always be sought from your JCB Dealer. JCB reserves the right to change specifications without notice. Illustrations and specifications shown may include optional equipment and accessories. The JCB logo is a registered trademark of J C Bamford Excavators Ltd.

